

# AMP FOURFRONT



## Operation Manual

**READ ENTIRE MANUAL BEFORE OPERATING MACHINE**

Congratulations on your purchase of AMP's FOURFRONT 9250 4 in 1.

American Motor Products is certain you will be satisfied with your purchase of the most innovative products on the market. The combination of Generator, Welder, Plasma Cutter, and Air Compressor is the first of its kind.

We want to help you get the best results from your new machine and to operate it safely. This manual contains the information on how to do that; please read it carefully. As you read this manual, you will find information preceded by a symbol. That information is intended to help you avoid damage to your machine, other property, or the environment.

We as a company are striving to make constant upgrades to our equipment to provide our customer base with the best units possible. The specifications for each unit may vary from machine to machine. For any questions, please call AMP at 877-601-2823.

# TABLE OF CONTENTS

<b>SECTION 1. SAFETY</b>	<b>Page 4</b>
<b>SECTION 2. SPECIFICATIONS</b>	<b>Page 14</b>
<b>SECTION 3. MACHINE BREAKDOWN</b>	<b>Page 15</b>
<b>SECTION 4. INSTALLATION</b>	<b>Page 19</b>
<b>SECTION 5. STARTING YOUR UNIT</b>	<b>Page 25</b>
<b>SECTION 6. OPERATION</b>	<b>Page 26</b>
<b>SECTION 7. SHUTTING UNIT DOWN</b>	<b>Page 30</b>
<b>SECTION 8. MAINTAINENCE</b>	<b>Page 30</b>
<b>SECTION 9. TROUBLESHOOTING</b>	<b>Page 31</b>
<b>SECTION 10. SCHEMATICS</b>	<b>Page 37</b>

# SECTION 1. SAFETY

## RECOGNIZE SAFETY INFORMATION

This is the safety alert symbol. When you see this symbol on your machine or in this manual, be alert to the potential for personal injury. Follow recommended precautions and safe operating practices.



## UNDERSTAND SIGNAL WORDS

A signal word--DANGER, WARNING or CAUTION--is used with the safety-alert symbol. DANGER identifies the most serious hazards. DANGER or WARNING safety signs are located near specific hazards. General precautions are listed on CAUTION safety signs. CAUTION also calls attention to safety messages in this manual.



## FOLLOW SAFETY INSTRUCTIONS

Carefully read all safety messages in this manual and safety signs on your machine. Keep safety signs in good condition. Replace missing or damaged safety signs. Be sure new equipment components and repair parts include the current safety signs. Replacement safety signs are available from your dealer. Learn how to operate the machine and how to use controls properly. Do not let anyone operate without instruction. Keep your machine in proper working condition. Unauthorized modifications to the machine may impair the function and/or safety and affect machine life. If you do not understand any part of this manual and need assistance, contact your dealer.



## CARBON MONOXIDE - POISONOUS GAS

Use unit outdoors, away from open windows, vents, or doors.



Unit exhaust contains carbon monoxide - a poisonous gas that can kill you. You **CAN NOT** smell or see this gas.

Never use the unit in enclosed or partially enclosed spaces. The unit can produce high levels of carbon monoxide very quickly. When you use this unit, remember that you cannot smell or see carbon monoxide. Even if you can't smell exhaust fumes, you may still be exposed to carbon monoxide.

If you start to feel sick, dizzy, or weak while using the unit, get to fresh air **RIGHT AWAY**. **DO NOT DELAY**. The carbon monoxide from the unit can rapidly lead to full incapacitation and death.

If you experience serious symptoms, get medical attention immediately. Inform medical staff that carbon monoxide poisoning is suspected. If you experienced symptoms while indoors, have someone call the fire department to determine when it is safe to re-enter the building.

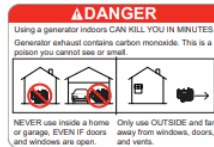

Never operate the unit in an explosive atmosphere, near combustible materials or where ventilation is not sufficient to carry away exhaust fumes. Exhaust fumes can cause serious injury or death.

**NEVER** use the unit indoors, including in homes, garages, basements, crawl spaces, and other enclosed or partially enclosed areas, even with ventilation. Opening doors and windows or using fans will not prevent carbon monoxide build-up in the home.

Follow the instructions that come with your unit. Locate the unit outdoors and away from doors, windows, and vents that could allow the carbon monoxide gas to come indoors.

**ONLY** run unit outdoors and away from air intakes.

**NEVER** run unit inside homes, garages, sheds, or other semi enclosed spaces. These spaces can trap poisonous gases **EVEN IF** you run a fan or open doors and windows.

If you start to feel sick, dizzy, or weak while using the unit, shut it off and get fresh air **IMMEDIATELY**. See a doctor. You may have carbon monoxide poisoning.

Install battery-operated carbon monoxide alarms or plug-in carbon monoxide alarms with battery back-up in your home, according to the manufacturer's installation instructions. The carbon monoxide alarms should be certified to the requirements of the latest safety standards for carbon monoxide alarms. (UL 2034, IAS 6-96, or CSA 6.19.01). Test your carbon monoxide alarm frequently and replace dead batteries.



### **SAFETY WARNING WHEN REFUELING**

Injury or death may occur because of improper fueling. Do not smoke while filling engine fuel tank.

Always refuel slowly to avoid the possibility of spilled fuel which may cause a risk of fire.

Gasoline is extremely flammable, and its vapors can explode if ignited.

Observe all safety regulations for the safe handling of fuel. Handle fuel in safety containers. If the container does not have a spout, use a funnel.

Do not overfill the fuel tank, leave room for the fuel to expand.

Fill the tank only on an area of bare ground. While fueling the tank, keep heat, sparks, and open flame away. Carefully clean up any spilled fuel before starting engine.

Always fill fuel tank in an area with plenty of ventilation to avoid inhaling dangerous fumes.

NEVER store fuel for your unit in the home. Gasoline, propane, kerosene, and other flammable liquids should be stored outside of living areas in properly labeled, non-glass safety containers. Do not store them near a fuel-burning appliance, such as a natural gas water heater in a garage. If the fuel is spilled or the container is not sealed properly, invisible vapors from the fuel can travel along the ground and can be ignited by the appliance's pilot light or by arcs from electric switches in the appliance.

## ELECTRICAL HAZARDS

This product must be grounded. If it should malfunction or breakdown, grounding provides a path of least resistance for electric current to reduce the risk of electric shock. Do not touch live electrical parts.



**DANGER - IMPROPER CONNECTION OF THE EQUIPMENT GROUNDING CONDUCTOR CAN RESULT IN A RISK OF ELECTROCUTION. CHECK WITH A QUALIFIED ELECTRICIAN OR SERVICE PERSON IF YOU ARE IN DOUBT AS TO WHETHER THE UNIT IS PROPERLY GROUNDED.**

This unit is equipped with a grounding terminal for your protection. Always complete the ground path from the unit to an external ground source as instructed in the section labeled “Grounding Instructions” in the Preparation section of this manual.

The unit is a potential source of electrical shock if not kept dry. Keep the unit dry and do not use in rain or wet conditions. To protect from moisture, operate it on a dry surface under an open, canopy-like structure. Dry your hands if wet before touching the unit.

Plug appliances directly into the unit. Or use a heavy duty, outdoor rated extension cord that is rated (in watts or amps) at least equal to the sum of the connected appliance loads. Check that the entire cord is free of cuts or tears and that the plug has all three prongs, especially a grounding pin.

**NEVER** try to power the house wiring by plugging the unit into a wall outlet, a practice known as “back feeding”. This is an extremely dangerous practice that presents an electrocution risk to utility workers and neighbors served by the same utility transformer. It also bypasses some of the built-in household circuit protection devices.

If you must connect the unit to the house wiring to power appliances, have a qualified electrician install the appropriate equipment in accordance with local electrical codes. Or check with your utility company to see if it can install an appropriate power transfer switch.

For power outages, permanently installed stationary units are better suited for providing backup power to the home. Even a properly connected portable unit can become overloaded. This may result in overheating or stressing the unit components, possibly leading to a unit failure.

Do not use worn, damaged, undersized, or poorly spliced welding cables. Do not drape welding cables over your body. Do not touch electrode if you are in contact with the work, ground, or another electrode from a different machine.

## RISK OF FIRE OR EXPLOSION



Serious injury or death may occur from normal sparks in the engine ignition system or engine exhaust/muffler. Always operate the unit in a well-ventilated area free of flammable vapors, combustible dust, gases, or other combustible materials. Do not weld where the atmosphere may contain flammable dust, gas, or liquid vapors (such as gasoline).

DO NOT SMOKE if spraying flammable material. Locate the unit at least 20 feet away from the spray area. (An additional hose may be required.)

Never fill the engine fuel tank while the engine is running or hot. Allow the engine to cool two minutes before refueling. Do not refuel indoors or in a poorly ventilated area.

Do not operate the unit if gasoline is spilled. Wipe the unit clean and move it away from the spill. Avoid creating any ignition until the gasoline has evaporated.

Do not store the unit near an open flame or any equipment such as a stove, furnace, water heater, etc. which utilizes a pilot light or sparking device.

A spark arrester must be added to the muffler of this engine if it is to be used on any forest covered, brush covered, or grass covered unimproved land. The arrester must be maintained in effective working order by the operator.

Serious injury may occur if any of the unit's ventilation openings are restricted, causing the unit to overheat and start a fire. Never place objects against or on top of the unit. Operate the unit at least 12 inches away from any wall or obstruction that would restrict proper ventilation.

Welding on closed containers, such as tanks, drums, or pipes, can cause them to explode. Accidental contact of electrode to metal objects can cause sparks, explosion, overheating, or fire.

Remove all flammables within 35 ft (10.7 m) of the welding arc. Do not weld where flying sparks can strike flammable material. Watch for fire and keep a fire extinguisher nearby.

After completion of work, inspect area to ensure it is free of sparks, glowing embers, and flames. Remove stick electrode from holder when not in use.





### **RISK OF Bursting**



Serious injury or death may occur from an air tank explosion if air tanks are not properly maintained. Drain air tank daily or after each use to prevent moisture buildup in the air tank.

If air tank develops a leak, replace the air tank immediately. Never repair, weld, or make modifications to the air tank or its attachments. Use only genuine manufacturer repair parts for your unit. NEVER adjust the factory set pressures.

Serious injury may occur from the unit malfunction or exploding accessories if incorrect system components, attachments or accessories are used. Never exceed manufacturers maximum allowable pressure rating of attachments.

Because of extreme heat, do not use plastic pipe or lead tin soldered joints for a discharge line.

Never use the unit to inflate small, low-pressure objects such as toys

### **RISK OF Breathing**

Serious injury or death could occur from inhaling compressed air. The air stream may contain carbon monoxide, toxic vapors, or solid particles. Never inhale air from the unit either directly or from a breathing device connected to the unit.

Serious injury or death may occur from inhaling engine exhaust. This unit was designed for outdoor use. Never operate this unit in an enclosed area. Always make certain there is adequate ventilation (fresh outside air) for breathing and combustion. This will prevent the buildup of dangerous carbon monoxide gases. Beware of poorly ventilated areas, or areas with inadequate exhaust fans.

Sprayed materials such as paint, solvents, paint remover, insecticides, weed killers, etc. contain harmful vapors and poisons. Operate the unit only in a well-ventilated area. Follow all safety instructions provided with the materials you are spraying. Use of a respirator may be required when working with some materials.

Welding produces fumes and gases. Breathing these fumes and gases can be hazardous to your health. Keep your head out of the fumes. Do not breathe the fumes.

Do not weld in locations near degreasing, cleaning, or spraying operations. The heat and rays of the arc can react with vapors to form highly toxic and irritating gases.

Do not weld on coated metals, such as galvanized, lead, or cadmium plated steel. The coatings and any metals containing these elements can give off toxic fumes if welded.

### **RISK OF Burns**

Serious injury could occur from touching exposed metal parts. These areas can remain hot for some time after the unit is shutdown.

Never allow any part of your body or other materials to contact any exposed metal parts on the unit. Never allow any part of your body to contact the engine muffler, compressor head or adjacent areas



### **RISK OF Flying Objects**

Soft tissue damage can occur from the compressed air stream. Always wear safety glasses to shield the eyes from flying debris.

Never point the air stream at any part of your body, anyone else or animals.

Never leave pressurized air in the unit. Shut off the unit and relieve pressure when storing or attempting maintenance.

Serious injury can occur from loose debris being propelled at a high speed from the compressed air stream. Always maintain a safe distance from people and animals while operating the unit.

Do not move the unit while air tank is under pressure. Do not attempt to move the unit by pulling on the hose.



### **RISK from Moving Parts**

Risk of bodily injury from moving parts. Before performing maintenance, always turn off the unit. Bleed pressure from the air hose and disconnect spark plug wire to prevent engine from starting unexpectedly. All repairs to the unit should be made by an Authorized Service person.

Do not operate without protective covers/guards. Always turn off the unit before removing any guard. Replace damaged covers/guards before using the unit.





### **IMPORTANT SAFETY INSTRUCTIONS**

**WARNING: To reduce the risk of injury, read this operator's manual completely before using. When using this product, the following basic precautions should always be followed:**

1. Risk from Negligence: Risk of injury from negligent use. Never allow children or adolescents to operate this unit! Stay alert and watch what you are doing. Do not operate the unit when fatigued or under the influence of alcohol or drugs. Know how to stop the unit. Be thoroughly familiar with controls.
2. Risk of Unit Damage: Risk of major repair. Do not operate the unit without an air filter. Do not operate the unit in a corrosive environment. Always operate the unit in a stable, secure position to prevent the unit from falling. Follow all maintenance instructions listed in this manual. Overuse can cause overheating; allow cooling period; follow rated duty cycle. Reduce current or reduce duty cycle before starting to weld again. Do not block or filter airflow to unit.
3. When starting the unit, using recoil starter grip, be sure that nothing can be hit by the operator's hand or arm. Be sure the switch on electric power tools is in the "OFF" position before plugging them into the unit.
4. Do not operate the unit or any electrical tool in any area where water or similar materials constitute an electrical hazard to the operator. Do not operate on wet surfaces, in rain or in snow.
5. Always be sure that the unit is on secure footing so that it cannot slide or shift around, endangering workers.
6. Avoid contacting the hot exhaust manifold, muffler, or cylinder(s).
7. Keep clear of all rotating parts.
8. Unless the tool or appliance is double insulated, it must be grounded through a properly grounded receptacle. Tools and appliances which have 3 prong plugs must be plugged into extension cords and electrical receptacles with 3 holes. Before operating any electrical item, be sure it is in good repair.
9. Beware of using this equipment in confined spaces. Confined spaces, without sufficient fresh air ventilation, can contain dangerous gases. Running gasoline engines in such environments can lead to deadly explosions and/or asphyxiation.
10. Use extreme caution when lifting this unit. This unit is heavy, so proper lifting techniques should be used.

**SAVE THESE INSTRUCTIONS**

### **Wear Protective Clothing**

Wear close fitting clothing and safety equipment appropriate to the job. Wear dry, hole-free insulating gloves and body protection.

Wear a suitable hearing protective device such as earmuffs or earplugs to protect against objectionable or uncomfortable loud noises.

Operating equipment safely requires the full attention of the operator. Do not wear radio or music headphones while operating machine.

Arc rays from the welding process produce intense visible and invisible (ultraviolet and infrared) rays that can burn eyes and skin. Sparks fly off from the weld. ARC RAYS can burn eyes and skin. Wear an approved welding helmet fitted with a proper shade of filter lenses to protect your face and eyes when welding or watching. Wear approved safety glasses with side shields under your helmet.

Use protective screens or barriers to protect others from flash, glare, and sparks; warn others not to watch the arc. Wear protective clothing made from durable, flame-resistant material and foot protection.

Welding, chipping, wire brushing, and grinding cause sparks and flying metal. As welds cool, they can throw off slag. Wear approved safety glasses with side shields even under your welding helmet.



### **PREPARE FOR EMERGENCIES**

Keep a first aid kit and fire extinguisher handy.

Keep emergency numbers for doctors, ambulance service, hospital, and fire department near your telephone.

Be prepared if a fire starts.

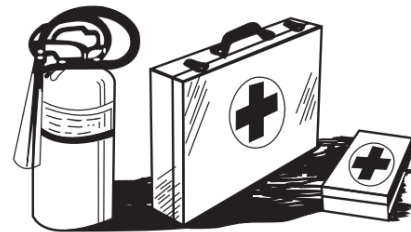

**Inspect your Unit!**

Be sure all covers; guards and shields are tight and in place.

Locate all operating controls and safety labels.

Inspect power cord for damage before using. There is a hazard of electrical shock from crushing, cutting or heat damage.

**Service Unit Safely**

Before servicing the unit, disconnect all equipment and battery (if equipped) and allow unit to cool down.

Service unit in a clean dry flat area

## SECTION 2. SPECIFICATIONS

FOURFRONT 9250 KEY SPECS		
<b>GENERATOR</b>	Rated Watts	6,000
	Max Watts	6,500
	Voltage	120V/240V
<b>ENGINE</b>	Engine Name	Kohler COMMAND PRO
	Engine Model	CH440-3174
	Engine Displacement	429cc
	Cooling System	Air Cooled
	Air Valve	OHV
	Low Oil Sensor?	Yes
	Start Modes	Manual, Key, Remote
	Ignition System	CDI Contactless Transistor
<b>WELDER</b>	Welding Type	DC Only
	Welding Current Range(amps)	50-170
	Welding Duty Cycle	50%
	No-Load Voltage	70
	Operating Voltage	22 - 26.4
	Rated Current (amps)	150
	Power Static Characteristic Curve	Descending Characteristic
<b>COMPRESSOR</b>	Air Tank Size(Gallon)	5
	Pressure(PSI)	115
	Air Output(cfm) @ 90 PSI	4.4
<b>PLASMA CUTTER</b>	Cut Thickness	max 1/2 in
	Current Range (amps)	10 - 40
	Rated Current (amps)	35
	Load Duration Rate	50%
<b>WHOLE MACHINE</b>	IP Rating	IP21
	Motor Insulation Grade	F
	Fuel Tank Size	7.96 Gallons
	Oil Capacity	1 Quart
	Net Weight(lbs.)	354
	Gross Weight (lbs.)	372
	Shipping Dimensions (in.)	34 x 25 x 39
	Assembled Dimensions (in.)	33 x 23 x 33

## SECTION 3. MACHINE BREAKDOWN

### 3.1 CONTROL PANEL

NOTE: DO ATTEMPT TO MODIFY THIS PANEL IN ANYWAY. THIS WILL VOID WARRANTY.

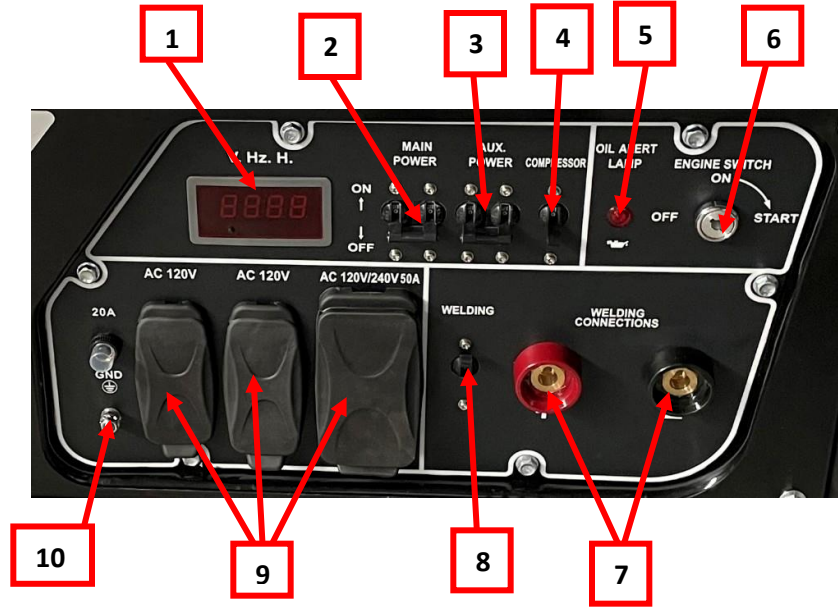

- |  |                                      |
|--|--------------------------------------|
| 1. Digital Display (Hours/Volts/Hertz) | 6. Ignition Switch                   |
| 2. Main Power Breaker                  | 7. Welding Terminals                 |
| 3. Auxiliary Power Breaker             | 8. Welder / Plasma Cutter Switch     |
| 4. Air Compressor Breaker              | 9. Generator Outlets                 |
| 5. Low Oil Alert                       | 10. Grounding Bolt (Not for Battery) |

### 3.2 PLASMA CUTTER

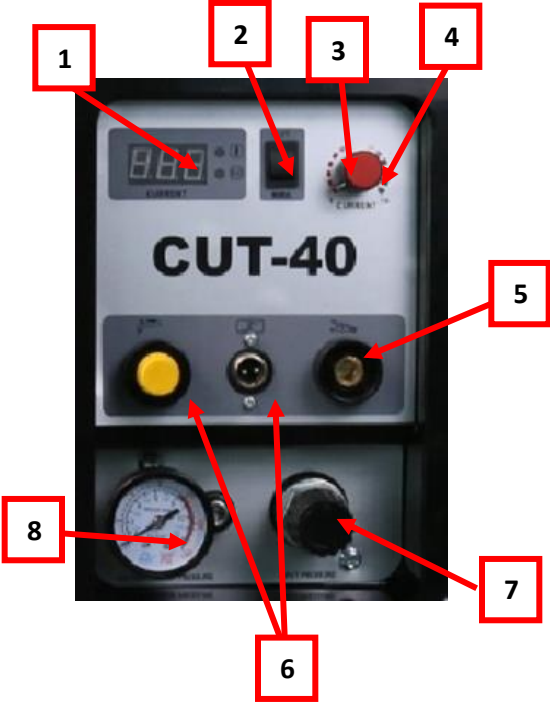

- |   |                                  |
|---|----------------------------------|
| 1. Current Display (Plasma Cutter Only)   | 5. Plasma Cutter Grounding Clamp |
| 2. Welder (MMA) Cutter (CUT) Switch       | 6. Plasma Cutter Positive Lead   |
| 3. Welder Current Range                   | 7. Air Pressure Regulator        |
| 4. Plasma Cutter/Welder Current Regulator | 8. Air Pressure Gauge            |



### 3.3 Machine

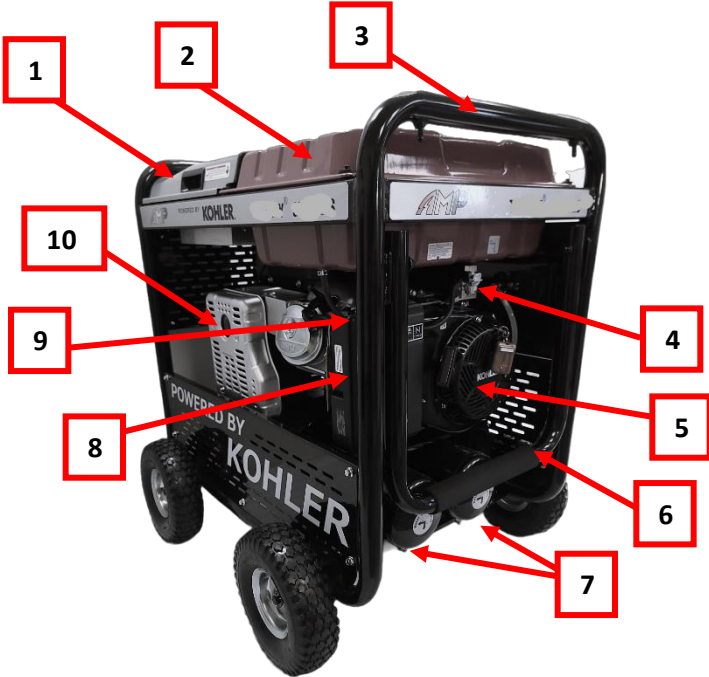

- |                           |                            |
|---------------------------|----------------------------|
| 1. Removable Access Panel | 6. Handle                  |
| 2. Fuel Tank              | 7. Water/Tank Drain Valves |
| 3. Frame                  | 8. Air Filter Housing      |
| 4. Fuel Shutoff Valve     | 9. Choke Lever             |
| 5. Engine Recoil Start    | 10. Muffler                |

### 3.4 Removable Panel

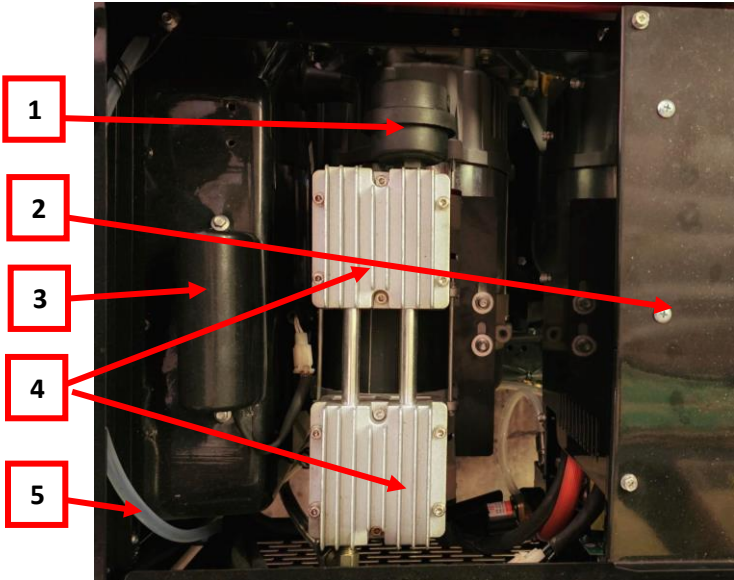

- 1. AC Filter
- 2. Plasma Cutter
- 3. AC Capacitor
- 4. AC Pump Heads
- 5. AC Manifold Supply Line

### 3.5 Front Access Locations

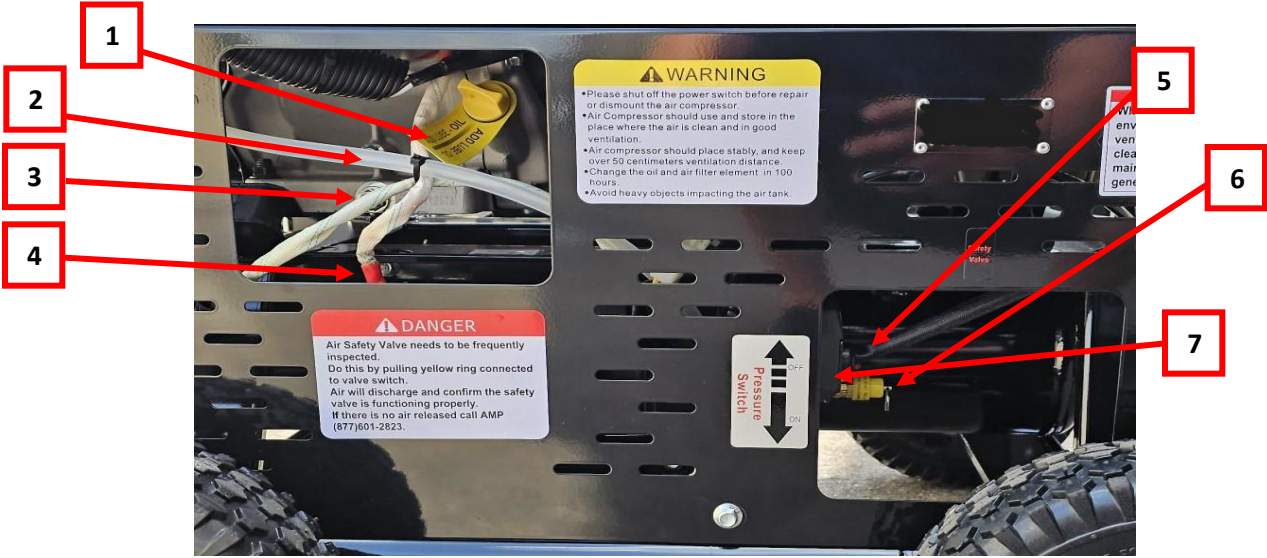

- |                        |                    |                               |                   |
|------------------------|--------------------|-------------------------------|-------------------|
| 1. Oil Fill/Check Plug | 2. Battery Ground  | 3. Low Oil Sensor             | 4. Oil Drain Plug |
| 5. Manual AC Switch    | 6. AC Safety Valve | 7. AC Pressure Relay Assembly |                   |

## 3.6 Air Compressor

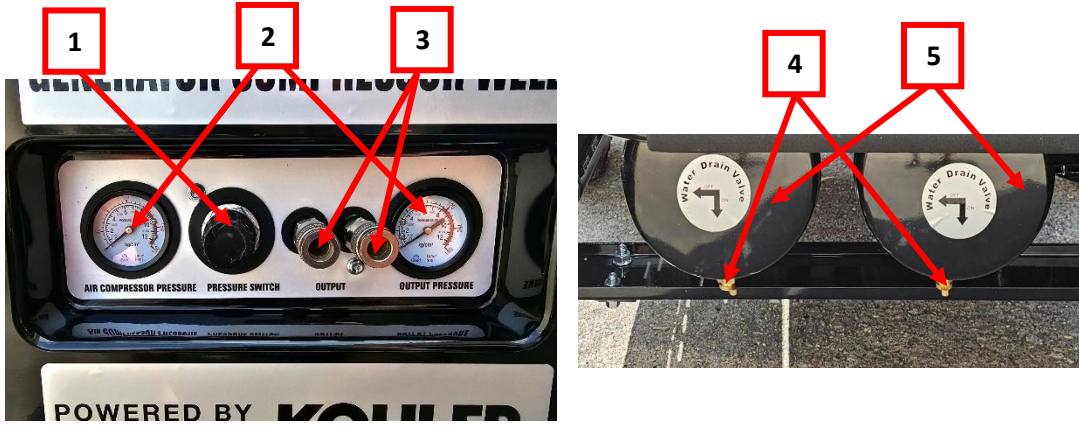

- |  |                        |                            |
|--|------------------------|----------------------------|
| 1. Air Pressure Regulator              | 2. Air Pressure Gauges | 3. Air Hose Quick Connects |
| 4. Pressure Release/Water Drain Valves | 5. AC Tank Assembly    |                            |

## SECTION 4. Installation

**4.1 READ THIS ENTIRE MANUAL.** Before starting the unit, please read this manual carefully, this will ensure you understand the equipment and get the longevity out of your investment.

**4.2 MAKE SURE WHEELS AND AXLES ARE INSTALLED CORRECTLY.** There are two axles for your machine. There are 4 bolts and nuts for each axle. The wheels slide on the end of each axle and should be secured with one washer and cotter pin. Make sure the axle bolts and nuts and cotter pins are fully tightened before moving the equipment.

**4.3 KEEP YOUR UNIT CLEAN AND DRY!** When operating the unit keep it in a clean, dry and well-ventilated place, and always in horizontal position for optimal performance.

**4.4 CHECK UNIT PRIOR TO OPERATING!** Inspect whether the unit parts are complete, whether the connecting bolts, nuts and other solid parts and joints are loose and falling off or breaking, and if there are, they should be repaired in time.

**4.5 Engine Break in Period!** The first 5 hours of run time are the break-in period for the unit. During the break in period stay at or below 50% of the running watt rating and vary the load occasionally to allow stator windings to heat and cool. Adjusting the load will also cause engine speed to vary slightly and help seat piston rings. After the 5-hour break-in period, change the oil.

**4.5 Inspection of engine oil.**

**4.5.1 CHECK YOUR OIL DIPSTICK.** Remove the oil fill plug and wipe dip stick clean.

**4.5.2 INSPECT FILL LINE.** Screw oil fill plug back into threads entirely, remove it again, check the oil level is correct.

**4.5.3 OIL LEVEL.** The oil should be in middle of the dipstick when cold. If the oil is too low, then add oil. If oil is spilling out of machine, then drain until correct amount is achieved.

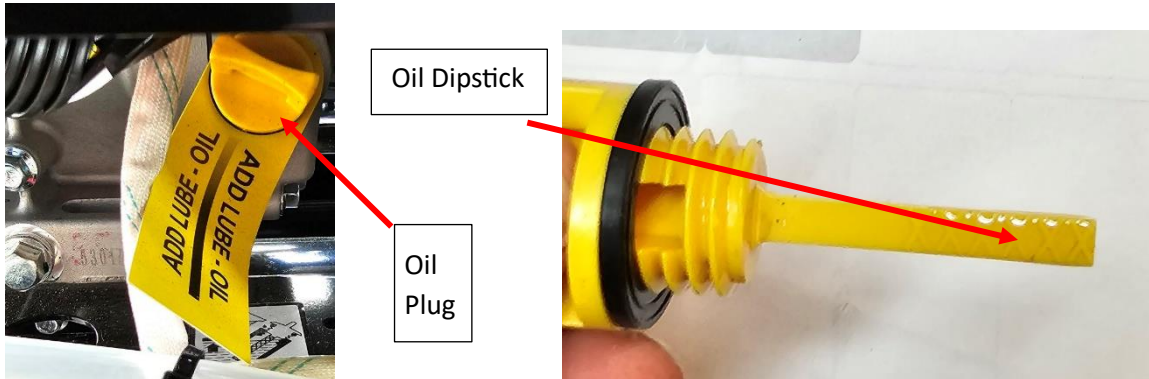

#### 4.6 Unit engine oil recommendation

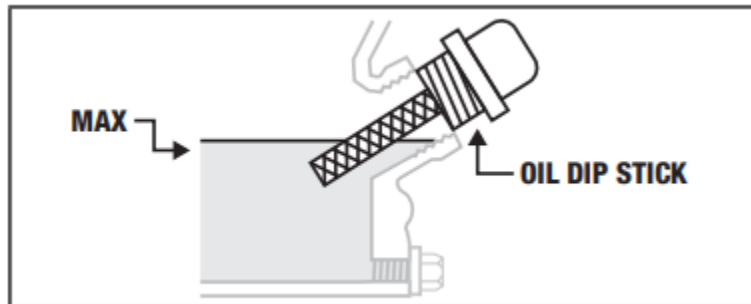

**4.6.1 KOHLER ENGINE MANUAL.** Engine oil is a major factor affecting the performance and service life of the unit. For engines, please refer to your Kohler Command PRO CH440-3174 Kohler Engine Manual.

**4.6.2 CHECK OIL BEFORE EACH USE.** Regularly check and replace the oil to avoid failure caused by the oil level is too low, too high, too dirty, and too thick.

**4.6.3 TEMPURATURE EFFECTS OIL TYPE.** SAE10W-30 oil is recommended. When the local average temperature is within the recommended range, oils of other viscosities shown in the chart can be used.

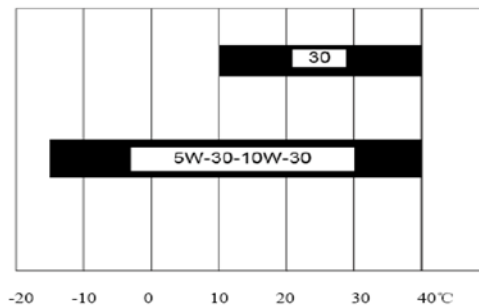

#### 4.7 FUEL LEVEL AND TYPE MATTER!

- Purchase gasoline in small quantities and store it in clean, approved containers.
- To minimize gum deposits in your fuel system and to insure it is important to check whether the fuel is sufficient, fill the fuel with a filter screen, and leave an appropriate space in the fuel tank to prevent accidents due to fuel expansion.
- The tank cap should be closed tightly after filling the tank.
- AMP recommends using Ethanol Free GASOLINE. The ethanol levels in 87, 89 and 93 will make carburetor replacements more frequent. Always add an ethanol stabilizer when using these types of gasoline.
- Do not use stale or contaminated gasoline or gasoline/petroleum mixtures to avoid dirt or water dripping into the tank.

#### **4.8 Air filter inspection**

4.8.1 Open the air filter clip and then open the air filter cover.

4.8.2 Remove 10 mm bolt at bottom of housing and loosen the hook from the top of the air filter box and remove the air filter cover, being careful not to damage the air filter cover.

4.8.3 Remove the filter element from the air filter cover.

4.8.4 Check whether the filter element of the air filter is clean and intact. If the air filter element is dirty, please clean it. If the air filter element is damaged, it must be replaced.

4.8.5 Reload the air filter element into the bottom cover of the air filter.

4.8.6 Reinstall the front housing in reverse order it was removed. Make sure the air filter is locked in tight so that there is no gap between the front and rear housing assemblies. NEVER run the generator without an air filter element installed. If the air filter element is damaged, dust will enter the engine, causing rapid wear of the engine.



#### **4.9 Panel check**

4.9.1 Turn off all the circuit breaker switches on the control panel.

4.9.2 Disconnect all cables from outlets on the control panel.

4.10 Electric start, please check that the voltage across the battery is 12.5-13V before starting the engine.

**4.11 Air Compressor Pre-Check.** Preparation before starting the air compressor.

4.11.1 Confirm the 4 in 1 unit meets the rated output volume and rated output pressure required by your job details.

#### 4.11.2 Air Compressor Details

Your AMP 4 in 1 pump is driven by a single-phase motor. The crankshaft rod raises the piston in the cylinder and pushes air into the compression chamber via your brass air filter. This decreases air volume and increases the pressure. The piston closes, forcing the compressed air out of the compression chamber by means of the braided discharge hose. It then passes through the check valve and into the storage tanks. It leaves the storage tank to the safety module and exits through the clear air tube to manifold. Allowing you to use the quick connect air chucks for usage. Then the piston opens again to draw in more air and start the process over.

This machine is designed with a safety switch also known as the "pressure relay automatic switch" to control the working state of the motor, when the air pressure of the air storage tank reaches the adjusted exhaust pressure (it has been adjusted before leaving the factory, please do not adjust it yourself) the air compressor must stop automatically. When the air pressure of the air receiver is

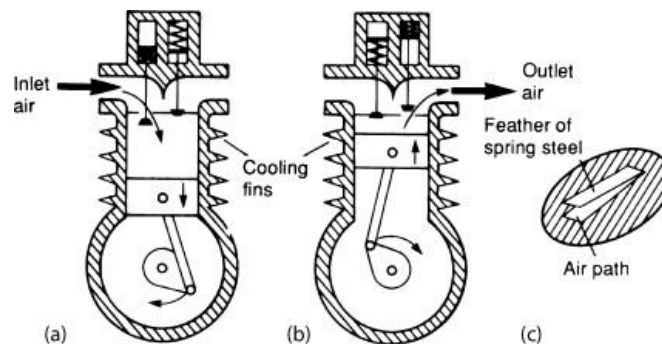

reduced to 0.6MPa, the compressor starts automatically. So that the pressure of the compressed air in the air storage tank is kept within a certain range, to achieve the purpose of automatically controlling the start and stop of the air compressor.

#### 4.11.3 Starting your Air Compressor:

4.9.3.1 Check that all valves are flexible in opening and closing, so that they are in the appropriate position and correct opening and closing state.

4.9.3.2 Check and confirm that all safety protection devices are in suitable operating condition.

4.9.3.4 Do not use the air compressor on people or livestock.

4.9.4 Inspecting your air compressor.

**4.11.4.1 Check your safety valve switch is working correctly.** Once the tank of machine has relative pressure, pull the pull ring of the safety valve to the right to ensure safety valve is operating correctly. If air release is abnormal, the air compressor must be stopped immediately.

**4.11.4.2 After each use of air compressor checklist!** Be sure to always drain all air pressure from the tanks. You then need to pull down each of the water drain valves to be sure no moisture is left as it will harm your machine. Never drain water with air left pressurized in the tanks.

**4.11.4.3 Air Compressor Auto Shutdown.** When operating the air compressor and the tanks fill between 111-120 PSI (adjusted before factory, do not adjust yourself), the motor will automatically kickoff. If the automatic shutoff of motor does not engage you must stop using air compressor function immediately.

**4.11.4.4 Air Compressor Auto Build up.** When operating the air compressor once you reach max PSI the motor will stop. It will automatically kick back on and build pressure when the air regulator is reduced to 87 PSI.

## **4.12 Starting your Air Compressor.**

4.12.1 Let your engine warm up for at least 2 minutes prior to using the air compressor. First, disconnect any cables plugged into your generator outlets that are not in use. Turn on the Main Breaker Switch located on control panel to on position. Next, you need to turn the pressure switch located on bottom of frame to the on position. Lastly, turn the Air Compressor Breaker located on the control panel to the on position.

Starting or stopping your air compressor should only be done by the breaker switch on your control panel. Never turn the engine off with the air compressor motor on.

There is a pressure relay switch located at the bottom of your machine next to the tanks. This is a controlled circuit with multiple connections. Any changes to the factory set air output settings will automatically engage this switch and will cause your air compressor to not turn on. This is an important part of ensuring the safe operation of the air compressor. If the exhaust pressure of the air compressor is higher than the rated value, the pressure relay will automatically disconnect the power supply to the air compressor. If it is lower than the rated value, the pressure relay will automatically close the power supply to the air compressor, and the output volume is automatically adjusted.

The air compressor is equipped with an automatic pressure release protection device (that is, a safety valve), which is separate from circuit control. This is to ensure that the pressure of the air compressor is always within the safe value.

**4.12.2 Monitor your gauges when operating Air Compressor.** To reduce the risk of accidents always monitor your air compressor output. If there is a sudden rise in pressure, failure to reach air output, failure of safety switch, Temperature of pump increasing, any abnormal noises, etc. Shut down the compressor immediately. Turn the whole machine off and then attempt to run the air compressor again. If the fault occurs again then call AMP at 877-601-2823.

## **4.13 Plasma Cutting**



Inverter cutting machine transfers the working voltage of 50/60Hz to high frequency (such as 30KHz) via single tube IGBT high-power device, then reduces the voltage and adjusts the current, delivers high-power cutting current via PWM technology.

#### **RULES TO FOLLOW WHEN CUTTING**

- Keep the plasma cutter in the off position when not in use.
- Connect ground lead as close to the area being cut as possible to ensure a good ground.
- Do not allow any body part to encounter the material being cut, or to the ground or electrode from another plasma cutter or welder.
- Do not cut if you are in an awkward position. Always have a secure stance while cutting to prevent accidents. Wear a safety harness if working above ground. -Do not drape cables over or around your body.
- Wear eye protection (see ANSI Z49.1 safety standard) while cutting to protect your eyes from harmful UV and IR ray's.
- Wear proper gloves and protective clothing to prevent your skin from being exposed to hot metals, UV and IR rays.
- Do not overuse or overheat your plasma cutter. Allow proper cooling time between duty cycles.
- Keep hands and fingers away from moving parts.
- Always keep fire extinguisher close by.
- Do not point the Plasma torch at any body part or at anyone else. -Always use this plasma cutter in the rated duty cycle to prevent excessive heat and failure.

#### **4.13.1 Preparation to use Plasma Cutter**

4.13.1.1 Inspect and confirm your pressure reducing device is firmly connected.

4.13.1.2 Install the air-electricity system plug to the socket in the panel and fix it clockwise. Air plug of the cutting torch and arc-keeping cable should be connected to relevant socket and fix the screw.

4.13.1.3 Put the loop cable plug to the fastening socket of the cutting machine panel and screw it clockwise. Connect the ground clamp to a clean workpiece.

4.13.1.4 Connect the cable as the picture shows, you can start cutting.

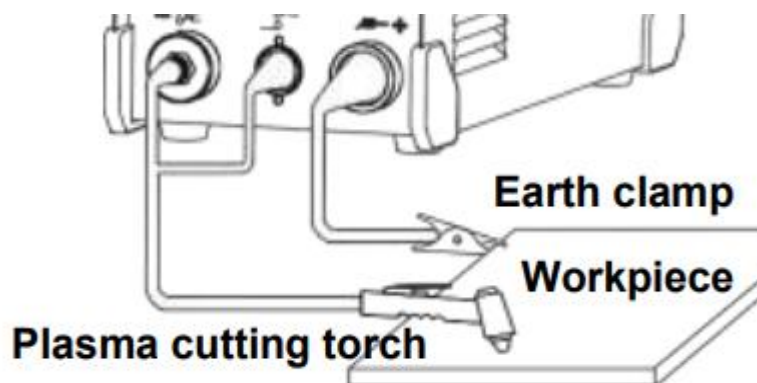



#### **4.13.2 Using the Plasma Cutter**

**4.13.2.1** Adjust the air pressure regulator on panel to 43 PSI.

**4.13.2.2** Turn the panel switch button to "CUT".

**4.13.2.3** When pressing the trigger on the torch will activate the magnetic valve. Plasma cutting torch nozzle will blow out plasma arc.

**4.13.2.4** Based on the thickness of the workpiece and the process requirements, set the appropriate cutting current.

**4.13.2.5 Metal Sheet Cutting** - Put the torch's nozzle at the start of the work piece. Press the torch trigger to ignite the plasma pilot. After the work piece is cut thorough, move the torch along the cutting direction uniformly. The cutting speed is determined by watching to see if the cutting goes all the way through. If the speed is too fast, the work piece won't be cut thorough, or if too slow, the cut quality would be affected, excessive warping may occur, or the arc could stop. When you've completed the cutting process, turn off the torch; the plasma pilot arc will stop.

**4.13.2.6 Metal Mesh Cutting** -Fix the work piece and connect the earth cable with the work piece. Put the cutting nozzle onto the work piece, lift torch up slightly from the work piece and press the trigger to cut.

**4.13.2.7 Monitor your unit while plasma cutting** - Unnecessary igniting of the pilot arc in the air will reduce the lifespan of the torch's electrode and nozzle. It is best to start cutting at the edge of the work piece, unless you are piercing the work piece. Keep a space between the nozzle and the work piece. Pressing the nozzle on the work piece could cause the nozzle to stick, reducing the smoothness of the cutting action creating an undesirable result. - Keep the torch's nozzle vertical against the work piece and watch to be sure the arc is moving along the cutting line. For thin materials reduce the amperage setting to get the best cutting quality, reduce excessive warping and to extend the life of the electrode and nozzle. Do not rapidly switch the torch trigger on and off; this will damage the pilot arc system and work piece.

## **Section 5. Starting your Unit**

5.1 Turn on the fuel valve. The "fuel valve" is located between the fuel tank and the carburetor. Always keep the fuel valve in an open position when running the unit. After each use make sure you close the valve. Never transport the machine with fuel valve open. It will cause damage to your air filter.

5.2 The choke lever is used to open and close the throttle valve in the carburetor. If the unit is not starting turn the choke lever on. Immediately after start-up, put the lever in the off position. This will ensure suitable fuel mixture for unit operation after start-up, and for heating engine start-up.

5.3 Ignition Controls

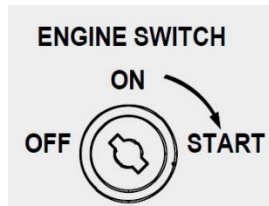

5.3.2 Recoil Start: Place the start key on the panel in the "ON" position, then gently pull the starting handle until you feel resistance, then pull quickly. If unsuccessful, repeat until the unit starts successfully. After start-up, the starting handle should be gently lowered back into the engine to avoid damage. Do not allow the rope to rub against the unit, otherwise the starting rope will wear out prematurely.

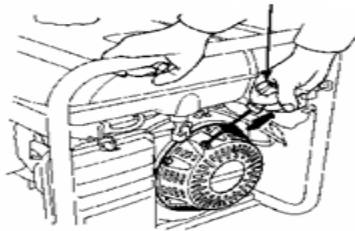

5.3.3 Remote control start: Put the starting key on the panel in the "ON" position, and then press the "ON" button of the remote control. If the start is unsuccessful, then you will need to turn the choke on and retry. Immediately after successful starting turn the choke off.

## Section 6. Operation

### Pre-Operation:

Check the engine oil level before starting. (See engine manual.) Fill the fuel tank according to the engine manual instruction.

Pump oil level should be checked before each use. Check the oil level indicator on the pump crankcase. Make certain the oil is in the center of the oil sight glass. If the level appears to be low, fill with SAE20 or 30 non detergent pump oil.

Remove any moisture in the unit's air tank.



**WARNING: NEVER ATTEMPT TO OPEN THE AIR TANK DRAIN VALVE WHEN MORE THAN 10 PSI OF AIR PRESSURE IS IN THE AIR TANK!**

Remove excessive pressure with an air tool, then open the Air Tank Drain Valve in the bottom of the air tank. Close tightly when drained. Make sure the Engine Switch is in the "OFF" position. Make sure the Safety Relief Valve is working correctly. Make sure all guards and covers are in place and securely mounted.

**START-UP:**

1. Read safety warnings before performing operation.
2. Make sure the unit is grounded. See Grounding Instructions.

NOTE: Unplug all equipment from the power receptacles before starting the unit.

3. Turn all breakers off before starting the unit

NOTE: READ KOHLER ENGINE MANUAL PRIOR TO STARTING

4. RECOIL (PULL START): Place the start key on the panel in the "ON" position, then gently pull the starting handle until you feel resistance, then pull quickly. If unsuccessful, repeat until the unit starts successfully. After start-up, the starting handle should be gently lowered back into the engine to avoid damage. Do not allow the rope to rub against the unit, otherwise the starting rope will wear out prematurely.

5. Electric start: Rotate clockwise to the starting position until the engine starts, and the gyration key is placed in the "on" position; If the startup is unsuccessful, try to start again in 30 second intervals.

6. Remote control start: Put the starting key on the panel in the "ON" position, and then press the "ON" button of the remote control. If the start is unsuccessful, then you will need to turn the choke on and retry. Immediately after successful starting turn the choke off.

7. Let Engine Warm up for 1-2 minutes.

8. Turn choke to off position.

NOW YOU ARE READY TO USE THE FUNCTIONS OF YOUR MACHINE!

**WELDING START-UP:**

**NEVER RUN THE WELDER AT THE SAME TIME AS THE GENERATOR OR AIR COMPRESSOR!**

1. Remove all AC electrical loads from the unit.
2. Inspect your welding lead connections.
3. Make sure your workpiece and grounding workpiece are clean and dry.
4. Turn Welder/Cutting Breaker on front control panel to on position.
5. Turn switch to MMA setting on Plasma Cutter Panel.

**GENERATOR START-UP:**

1. Make sure all breakers are in off position.
2. Plug in tool to generator outlet.
3. Turn on Main Break
4. Turn on Auxiliary Breaker

**PLASMA CUTTER START-UP:**

1. Turn on the Welder/Cutter Breaker on control panel.
2. Turn switch to CUT located on plasma cutter panel.
3. Adjust the air pressure regulator on panel to 43 PSI.
4. When pressing the trigger on the torch will activate the magnetic valve. Plasma cutting torch nozzle will blow out plasma arc.
5. Based on the thickness of the workpiece and the process requirements, set the appropriate cutting current.

**AIR COMPRESSOR START-UP:**

1. Make sure the manual switch on safety valve is turned on.
2. Turn on Main Breaker
3. Turn on Compressor Breaker
4. Set Pressure Regulator to desired air volume.

6.1 Ambient temperature: 50°F~104°F during welding.

6.2 During transportation and storage: -4 °F ~ 140 °F.

6.3 Relative humidity: at 104 °F: relative humidity should be ≤ 50%; At 68°F: the relative humidity should be ≤ 90%. Use altitude ≤ 1000 meters.

6.4 Tilt angle: The tilt angle of the welding power supply should not exceed 10 degrees.

6.5 **Overloading your Generator:** If you plug in into outlet and the breaker automatically closes it means the cord of item has short circuit or you are overloading the capacity of generator wattage or amperage output. First, inspect the item you are powering and ensure it works on other outlets available. Secondly, find out the amperage and wattage needed to power the item. This can be found on the item itself or on the cord of the item.

**6.6 Welding Electrode Chart.** Each welding rod has its own range of amperage to correctly burn the rod. Use the chart below as a guide for knowing where the amperage on welder needs to be set depending on the rod you're working with at the time.

ELECTRODE	DIAMETER	AMPS	50	75	100	125
6010 & 6011	3/32			■		
	1/8			■	■	
6013	5/32					■
	3/32		■			
	1/8				■	
7018	5/32					■
	3/32			■		
	1/8				■	■

**6.7 Digital Meter Display.** Your Digital Display Meter has 3 settings. They can be changed by pushing the button in bottom left corner of the display. The setting rotates between Hours (Run time), Frequency, and Voltage. There are no error codes for units sent from this display it is strictly these 3 settings.

**6.8 Generator Location.**

6.8.1 NEVER operate the generator inside any building, garage, basement, crawlspace, shed, enclosure, or compartment, including a generator compartment of a recreational vehicle.

6.8.2 NEVER operate or start the generator in the back of an SUV, camper, trailer, truck bed (regular sides, flat or other configuration), under staircases, stairwells, next to walls or buildings or in any other location that will not allow for adequate cooling of the generator or for the proper exit of the exhaust flow from the muffler system.

6.8.3 DO NOT operate or store the generator in wet weather conditions such as rain or snow. Using a generator in wet conditions could result in serious injury or death due to electrocution. In some states generators may be required to be registered with the local utility company when used at construction sites and may be subject to additional rules and regulations, consult your local municipal authority.

6.8.4 Generators should always be operated on a flat, level surface at all times (even when not in operation).

6.8.5 Generators must have a minimum of 5 feet (1.5 m) of clearance from all combustible material.

6.8.6 Generators must also have a minimum of 3 feet (91.4 cm) of air flow clearance on all sides to allow for adequate performance cooling, maintenance, and servicing. Always place the generator in a well-ventilated area.

6.8.7 NEVER place the generator near air intake vents or where exhaust fumes can be drawn into occupied or confined spaces. Always carefully consider wind and air currents when positioning the generator.

6.8.7 Always allow generators to properly cool before transport or for storage purposes. Failure to follow proper safety precautions may result in personal injury, damage to the generator, and void the manufacturer's warranty.

**6.9 Use a surge protector when powering sensitive electronics!** Electronic devices, including computers and many programmable appliances use components that are designed to operate within a narrow voltage range and may be affected by momentary voltage fluctuations. While there is no way to prevent voltage fluctuations, you can take steps to protect sensitive electronic equipment. – Install UL1449, CSA-listed, plug-in surge suppressors on the outlets feeding your sensitive equipment. Surge suppressors come in single- or multi-outlet styles. They're designed to protect against virtually all short-duration voltage fluctuations.

**6.10 Prolong the life of your Machine!** To prolong the life of your unit and attached devices, follow these steps to add electrical load:

1. Start the generator with no electrical load attached.
2. Allow the engine to run for several minutes to get up to temperature.
3. Make sure all circuit breakers are set to the running position.
4. Plug in and turn on the first item. It is best to attach the item with the largest load first.
5. Allow the engine to stabilize.
6. Plug in and turn on the next item.
7. Allow the engine to stabilize.
8. Repeat steps 5-6 for each additional item

## Section 7. Shutdown

### 7. Shutting Unit Down

**7.1 Prior to shutting Engine Down:** Turn off the circuit breaker switch if you are using the generator. Shut off Air Compressor Breaker and empty all air from the tanks. Do not shut off the unit while welding. Let the unit run with no-load for 2-3 minutes, and turnkey on the panel to the "off" position.

**7.2 Transporting or Long-Term Storage of your Machine.** Follow the steps in 7.1. Turn the fuel shutoff valve to the off position. Let the unit run until it automatically shuts to make sure all fuel in carburetor has burned off. This will ensure no residual fuel in the carburetor will cause any issues while in transport or the next time you try to start it.

**7.3 Inspect your machine after each use.** After the unit is shut down inspect the entire unit for any potential maintenance that needs to be done.

## Section 8. MAINTAINENCE

8.1 Make certain that your machine is kept clean and stored properly. Only operate the unit on a flat, level surface in a clean, dry operating environment. DO NOT expose the unit to extreme conditions, excessive dust, dirt, moisture or corrosive vapors

8.2 The owner/operator is responsible for all periodic maintenance. Any major maintenance or repairs beyond your abilities should be left to professional technicians. Call AMP at 877-601-2823 for any information you need.

8.3 If you're operating in dusty environments, the maintenance schedule timeline should be cut in half.

8.4 Refer to the maintenance section of the Engine Owner's Manual for the maintenance schedule, spark plug servicing, air filter replacement, etc.

**8.5 Cleaning your Unit. Never directly spray the generator with water.**

8.5.1. Use a damp cloth to clean the exterior surfaces of the generator.

8.5.2. Use a soft bristle brush to remove dirt and oil.

8.5.3. Use an air compressor (25 PSI) to clear dirt and debris from the generator.

8.5.4. Inspect all air vents and cooling slots to ensure that they are clean and unobstructed. To prevent accidental starting, remove and ground the spark plug wire before performing any service.

**8.6 Cleaning your Air Filter.**

8.6.1. Remove the Snap-On cover holding the air filter to the assembly.

8.6.2. Remove the foam element.

8.6.3. Wash in liquid detergent and water. Squeeze thoroughly dry in a clean cloth.

8.6.4. Saturate in clean engine oil.

8.6.5. Squeeze in a clean, absorbent cloth to remove all excess oil.

8.6.6. Place the filter in the assembly.

8.6.7. Reattach the air filter cover and snap in place.

**Section 9. Troubleshooting**

**AMP 4 in 1 Troubleshooting Guide**

Troubleshooting links can be found @ [www.ampgenerators.com](http://www.ampgenerators.com)

**A. Welder**

<b>Trouble</b>	<b>Remedy</b>
<b>No weld output; no generator power output at Receptacles</b>	Be sure all equipment is disconnected from receptacles when starting unit.
	Inspect Carbon Brush Assembly. Guide on AMP Website.

	Inspect AVR. Guide on AMP website.
	Call AMP @ 877-601-2823 before inspecting rotor, stator, slip rings or generator set voltage.
<b>No weld output: Generator power output at Receptacles is OK</b>	Check amperage control setting chart on page 19.
	Inspect welding lead connections on ground and stinger clamps
	Clean your grounding clamp and workpiece you're grounding on
	Call AMP @ 877-601-2823 for more information
<b>High Weld Output</b>	Check amperage control setting
	Review 9 Common Stick Welding Issues on AMP's Website
	Call AMP Technician @ 877-601-2823
<b>Erratic Weld Output</b>	Check amperage control setting. Replace current regulator if no change in amperage when checked.
	Tighten and clean connections to electrode and workpiece
	Use dry, properly stored electrodes for stick welding
	Review 9 Common Stick Welding Issues on AMP's Website
	Call AMP Technician @ 877-601-2823
<b>B. Generator</b>	
	Be sure all equipment is disconnected from receptacles when starting unit.



<b>No output power on Generator receptacles; no weld output</b>	Inspect all electrical cords
	Circuit Breaker is open. Reset the Circuit.
	Inspect Carbon Brush Assembly. Guide on AMP Website.
	Inspect AVR. Guide on AMP website.
	Call AMP @ 877-601-2823 before inspecting rotor, stator, slip rings or generator set voltage.
<b>Generator cannot Supply Enough Power</b>	Generator is overloaded
	Clogged or Dirty Air Filter
<b>C. Air Compressor</b>	
<b>AC pumps no air; Generator working correctly</b>	Residual air left in tanks exceeds the pressure limit. Drain the tanks. Try to operate it after doing so.
	The Circuit Breaker is tripped. Reset the breaker.
	The Safety Switch Module Manual On/Off is Off. Flip to on position.
	Overheating thermal protection activated. Let cool for 30 minutes and try again.
	The Capacitor has failed. Replace Capacitor.
	Review Air Compressor Pump Troubleshooting guide in Troubleshooting section of AMP website.
	Call AMP @ 877-601-2823 for any questions.
	Inspect Carbon Brush Assembly. Guide in Troubleshooting Section of AMP website.

<b>AC pumps no air; Generator produces no power</b>	Inspect AVR. Guide in Troubleshooting Section of AMP website.
	Call AMP @ 877-601-2823 before inspecting rotor, stator, slip rings or generator set voltage.
<b>Low Pressure/Overheating</b>	Output Pressure is too high. Decrease pressure at Manifold.
	The tank drain valve is open. Close the valve
	There is a leak at a fitting. Check fitting with soapy water. Tighten where loose.
	There is a leak in your air hose. Replace Hose.
	The compressor is not large enough for your demand.
	Gaskets are damaged on compressor head. The pump needs to be replaced.
	The safety valves or pressure relays need to be inspected. Replace if faulty.
<b>Air Leaks from Manifold</b>	Check the manifold. Replace regulator or manifold.
<b>D. Plasma Cutter</b>	
<b>Plasma Arc Blows Out</b>	The torch is being held too far from work piece. Hold closer.
	Improperly loaded consumables. Reload Correctly.
	Worn or Damaged Consumables. Replace
	Supply Air Pressure Too Low. Increase Pressure.

<b>Arc will not transition from Pilot to Cutting Arc</b>	Poor Ground Connection. Check ground.
	Worn out or damaged ground clamp. Replace Clamp.
	The torch being held too far from work piece. Hold closer.
	Supply Air Pressure Too Low. Increase Pressure.
<b>Cut will not go through work piece</b>	Improperly installed consumables. Install properly.
	Worn or Damaged Consumables. Replace
	Incorrect amperage or air pressure setting. Correct settings.
	Incorrect Cutting Speed. Slow down or speed up torch speed.
	Worn out or damaged ground clamp. Replace Clamp.
	Supply Air Pressure Too Low. Increase Pressure.
	Material Thickness is too thick.
<b>E. Engine</b>	
<b>Engine will not Start</b>	Not enough Fuel. Add Fuel.
	Faulty Spark Plug. Replace Spark Plug.
	Low Oil Level. Check Oil.
	Spark Plug Wire Loose. Tighten connection.

	Fuel Valve is off. Turn it on.
	If pull starting: Key needs to be in middle position.
	Old Fuel or Water in Fuel. Drain and replace fuel.
	Flooded with Fuel. Let the unit sit for 10 minutes.

# Section 9. Wiring Diagram

